

Gas Electro-Mechanical Valves

INSTRUCTION MANUAL



Please read the operating and mounting instructions before using the equipment. Install the equipment in compliance with the prevailing regulations.

Bedrijfs- en montagehandleiding voor gebruik goed lezen! Apparaat moet volgens de geldende voorschriften worden geïnstalleerd.

Lire les instructions de montage et de service avant utilisation! L'appareil doit impérativement être installé selon les réglementations en vigueur.

Betriebs- und Montageanleitung vor Gebrauch lesen! Gerät muß nach den geltenden Vorschriften installiert werden.

MANUFACTURER AND IMPORTER ADDRESSES

Below are the addresses and contact information for the Honeywell – Maxon manufacturing location and European sales office. The European sales office serves as the importer and EU manufacturer's representative under the EU New Legislative Framework (NLF).

MUNCIE, INDIANA, USA – MANUFACTURER

201 East 18th Street
P.O. Box 2068
Muncie, IN 47307-0068

Tel: 765.284.3304

Fax: 765.286.8394

EUROPEAN SALES OFFICE – IMPORTER

BELGIUM
Maxon International BVBA
Luchthavenlaan 16-18
1800 Vilvoorde, Belgium

Tel: 32.2.255.09.09

Fax: 32.2.251.82.41



WARNING





The installation, operation and maintenance instructions contain important information that must be read and followed by anyone operating or servicing this product. Do not operate or service this equipment unless the instructions have been read. IMPROPER INSTALLATION OR USE OF THIS PRODUCT COULD RESULT IN BODILY INJURY OR DEATH.

Nameplate and abbreviations

Consult the nameplate of your valve. This lists the maximum operating pressure, temperature limitations, voltage requirements and service conditions of your specific valve. Do not exceed nameplate ratings.

Description

MAXON electro-mechanical valves are electrically actuated fuel shut-off valves. The valves are designed for a fast acting return to the at rest position upon removal of a control voltage signal. Motorized automatic and manual actuators are available depending on application needs. In addition, normally-closed and normally-open options are available. The normally-closed versions will shut off flow when de-energized and pass flow when energized. The normally-open versions will shut off flow when energized and pass flow when de-energized. Electro-mechanical valves are also offered in configurations that meet hazardous locations.

Abbreviation or symbol	Description
M.O.P.	Maximum operating pressure
OPENING	Valve opening time (for automatic valves only). Units shown in seconds.
	Solenoid/clutch voltage and frequency
	Motor voltage and frequency
T _{AMB}	Ambient temperature range
T _F	Fluid temperature range
SHUT	Visual indication that valve is shut
OPEN	Visual indication that valve is open
SPDT (HS)	Single pole double throw hermetically-sealed switch(es)
SPDT	Single pole double throw switch(es)
SPDT (HC)	Single pole double throw high capacity switch(es) (used when DC motors are ordered)
DPDT	Double pole double throw switch(es)
GENERAL PURPOSE AREA	Designates components used in general purpose areas
DIVISION 2 AREA	Designates components used in Division 2 hazardous locations areas
	Valve is shut
	Valve is partially open
	Valve is full open
VOS-1/2	Valve open switch(es)
VCS-1/2	Valve closed switch(es); proof of closure

Component identification

- 1) Access cover screws
- 2) Access cover
- 3) Visual indication
- 4) Mainbase
- 5) Nameplate
- 6) Actuator bolts
- 7) Flow arrow
- 8) Valve body
- 9) Terminal block cover screws
- 10) Terminal block cover
- 11) Motor cover screws
- 12) Motor cover
- 13) Top cover plate screws
- 14) Top cover plate
- 15) Top housing
- 16) Top housing screws

Automatic (motorized) valve
Model designation
SMA11, CMA11, SMA21, CMA21

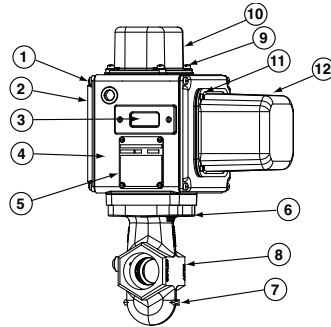

Manual valve
Model designation
SMM11, CMM11, SMM21

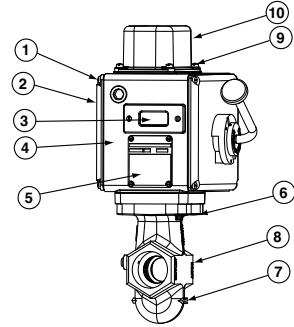

Automatic (motorized) valve - 4" & 6" high capacity
Model designation
HMA11

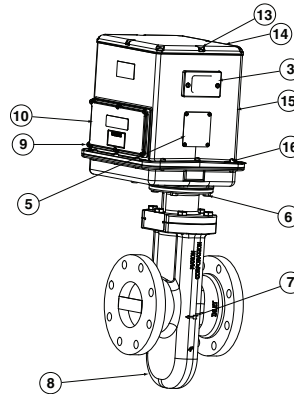

Table 1 - Torque specifications

Valve type	Item number	Description	Torque
"S" Valves 3/4" - 1-1/2"	1	Access cover screws 1/4-20	72 in-lbs
	6	Actuator bolts 5/16-18	13 ft-lbs
	9	Terminal block cover screws 1/4-20	72 in-lbs
	11	Motor cover screws #10-24	42 in-lbs
"S" Valves 2" - 3"	1	Access cover screws 1/4-20	72 in-lbs
	6	Actuator bolts 3/8 - 16	20 ft-lbs
	9	Terminal block cover screws 1/4-20	72 in-lbs
"C" Valves 2" - 4"	1	Access cover screws 1/4-20	72 in-lbs
	6	Actuator bolts 3/8 - 16	20 ft-lbs
	9	Terminal block cover screws 1/4-20	72 in-lbs
	11	Motor cover screws #10-24	42 in-lbs
"H" Valves 4" - 6"	9	Terminal block cover screws #10-24	42 in-lbs
	13	Top cover plate screws 1/4-20	72 in-lbs
	16	Top housing screws 1/4-20	72 in-lbs

INSTALLATION

1. A gas filter or strainer of 40 mesh (0.6 mm) or smaller is recommended in the fuel gas piping to protect the downstream safety shut-off valves.
2. Properly support and pipe the valve in the direction of the flow arrow on the valve body. Valve seats are directional. Sealing will be maintained at full rated pressures in one direction only. Sealing will be provided in reverse flow only at reduced pressures.
3. Mount valve so that open/shut window indicator will be visible to your operating personnel. The open/shut window indicator should never face downward. The valve side plates should be located in a vertical plane for best performance. Valves are usually installed in horizontal piping; however, other orientations are acceptable, subject to the above limitations. The top assemblies of all MAXON valves are field rotatable to allow installations involving conflicts with these mounting restrictions.
4. Wire the valve in accordance with all applicable local and national codes and standards. In U.S. and Canada, wiring must conform to the NEC ANSI/NFPA 70 and/or CSA C22.1, Part 1.
 - Supply voltages must agree with valve's nameplate voltage within -15%/+10% for proper operation. For electrical wiring schematic, see instructions or sample affixed inside valve terminal block cover.
 - Grounding is achieved with a grounding screw, which is located in the top assembly.
 - Customer connections are provided via terminal blocks located in the top assembly.
 - Main power wiring (120 VAC or 240 VAC) must be segregated from lower voltage 24 VDC signal wiring, when both are required.
 - To eliminate any potential for gas to enter the electrical wiring system, install a conduit seal fitting at the actuator conduit hub.
5. Maintain integrity of the electro-mechanical actuator enclosures by using the appropriate electrical connectors for the (2) 3/4" NPT conduit threaded connections. The electrical enclosure is NEMA 4 rated with an option for NEMA 4X.
6. All access cover plate screws should be tightened using a torque wrench in an alternate cross-corner tightening pattern to the values shown in "Table 1 - Torque specifications" on page 3.
7. Verify proper installation and operation by electrically actuating the valve for 10-15 cycles prior to the first introduction of gas.
8. **WARNING - Explosion hazard**
 - **Do not connect or disconnect this equipment unless power has been removed or the area is known to be non-hazardous.**
 - **Substitution of components may impair suitability for Class I, Division 2 (applies to MM12, MA12, MM22 and MA22 valves only).**
9. This equipment is suitable for installation in Class I, Division 2 Groups B, C, D, and Class II Groups F and G, and Class III hazardous locations or non-hazardous locations (applies to MM12, MA12, MM22 and MA22 valves only).
10. Never test gas valves, or the pipeline they are in, with liquids. The design of the body prevents removal of the liquid after testing, which can cause erratic function or failure.









Auxiliary features

- **Non-adjustable proof of closure switch(es) with valve seal over travel interlock**
- **Auxiliary switch for indication of full travel (open for normally-closed valves, closed for normally-open valves)**

Operating environment

- **Actuators rated for NEMA 4 or optional NEMA 4X**
- **Ambient and fluid temperature range of -20°F to +140°F for S and C Model constructions**
- **Ambient and fluid temperature range of -20°F to +125°F for H Model constructions**
- **All valves for oxygen service or using Ethylene Propylene body seals are limited to a minimum ambient and fluid temperature of 0°F**

AGENCY APPROVALS AND CERTIFICATIONS

	General Purpose Valves SMA11, SMM11, CMA11, CMM11, SMA21, SMM21, CMA21, HMA11		Non-incendive/Non-sparking Valves SMA12, SMM12, SMA22, CMA22, CMA12, CMM12, SMM22, CMM22	
	Standards	Markings	Standards	Markings
FM Approvals	FM 7400		FM 3600 FM 3611 FM 3810	Class I, Div. 2, Groups ABCD Class II, Div. 2, Groups FG Class III, Div. 2 Temp Code T4 (AC) T3 (DC, sizes 3/4" - 1-1/2") T3C (DC, sizes 2"-6") 
IECEX	Not applicable		IEC 60079-0 IEC 60079-15 IEC 60079-31	Ex nA nC IIC T4A (AC), T3 (DC), Gc Ta=60°C Ex tc IIIC T135°C Dc IP65 IECEX FMG 11.0032X
UL	UL 429		Not applicable	Not applicable
CSA	CSA 6.5 CSA 139	 	CSA 22.2 No. 0 CSA 22.2 No. 0.4 CSA 22.2 No. 25 CSA 22.2 No. 94 CSA 22.2 No. 142 CSA 22.2 No. 213	Class I, Div. 2, Groups ABCD Class II, Div. 2, Groups FG Class III
European GAR, LVD, EMC Compliance	EN 161 EN 13774		Not applicable	Not applicable
European PED Compliance				
SIL	IEC 61508	None	IEC 61508	None
KTL approvals	None	None	Not applicable	MA12: 12-KB4BO-0057 MM12: 13-KB4BO-0419 MA22: 16-KA4BO-0027X MM22: 16-K4BO-0028X 
AGA Certifications	AS 4629 (CLASS 1)	None	AS 4629	None
Chinese Approvals	None	None	GB 3836.1, GB 3836.8, GB 12476.1, GB 12476.5	Ex nA nC IIC T4(AC), T3(DC) Gc, Ex tD A22 IP65 T135°C 

Gas Appliance Regulation (EU) 2016/426 (Does not include 400HMA11 or 600HMA11 valves)
 Low Voltage Directive (2014/35/EU)
 EMC Directive (2014/30/EU)
 Pressure Equipment Directive (2014/68/EU) up to 4"
 Class A, Group 2 per EN 161

Valve cycle requirements

This is based on the standards that MAXON valves are approved to and the corresponding minimum number of cycles to be completed without failure as shown in the chart below.

	UL (UL 429)	CSA (CSA 6.5)	FM (FM 7400)	European (EN161)
Automatic Series MA11, MA12	100,000	100,000	20,000	<= 1" 200,000 <= 3" 100,000 <= 6" 50,000
Manual Series MM11, MM12	6,000	20,000	20,000	No special requirements
Vent valves Series MA21, MA22, MM21, MM22	6,000	No special requirements	No special requirements	No special requirements

VALVE MODEL NUMBER DESCRIPTION

Every MAXON gas electro-mechanical valve can be accurately identified by the model number shown on the valve nameplate. The example below shows a typical gas electro-mechanical valve model number, along with the available choices for each item represented in the model number.

Configured item number					Valve body					Actuator						
Valve size	Flow capacity	Valve type	Normal position	Area classification	Body connection	Body seals & bumper material	Body material	Internal trim package	Solenoid OR circuit board voltage	Motor voltage OR handle side plate	Motor timing (automatic valves only)	Switch options	Enclosure rating	Instruction language		
300	C	MA	1	1	-	A	A	1	1	-	B	B	2	0	A	0

Valve size

075 - 3/4" (DN20)
 100 - 1" (DN25)
 125 - 1-1/4" (DN32)
 150 - 1-1/2" (DN40)
 200 - 2" (DN50)
 250 - 2-1/2" (DN65)
 300 - 3" (DN80)
 400 - 4" (DN100)
 600 - 6" (DN150)

Flow capacity

S - Standard
 C - CP body construction
 H - High capacity

Valve reset type

MA - MAXON automatic (motorized) valve
 MM - MAXON manual valve

Normal position

1 - Normally closed shut-off valve
 2 - Normally open vent valve

Area classification

1 - General purpose
 2 - Non-incendive, Class I, II and III Division 2
 4 - Valve body only (400 & 600 high capacity valves only)

Body connection

A - ANSI (NPT) threaded
 B - ANSI flanged (PN20)
 C - ISO 7/1 threaded
 D - DIN PN16 flanged
 E - Socket welded nipple
 F - Socket welded nipple w/Class 150 flange (ISO 7005 PN20)
 H - EN1092-1 PN16 flanged (ISO 7005-1 PN16)

Body seals & bumper material

A - Buna o-rings/Buna bumper
 B - Viton o-rings/Buna bumper
 C - Viton o-rings/Viton bumper ¹
 D - Ethylene propylene o-rings w/Ethylene propylene bumper ¹
 E - Omniflex o-rings/Buna bumper
 F - Omniflex o-rings/Viton bumper ¹

Body material

1 - Cast iron
 2 - Carbon steel
 5 - Stainless steel
 6 - Low temp carbon steel

Internal trim package

1 - Trim package 1
 2 - Trim package 2
 4 - Trim package 2, oxy clean ¹

Solenoid OR circuit board voltage

A - 115VAC 50 Hz
 B - 115VAC 60 Hz
 C - 230VAC 50 Hz
 D - 230VAC 60 Hz
 E - 208VAC 50 Hz
 F - 24VDC
 G - 120VDC

Motor voltage

A - 115VAC 50 Hz
 B - 115VAC 60 Hz
 C - 230VAC 50 Hz
 D - 230VAC 60 Hz
 E - 24VDC

OR Handle side plate

A - Standard handle

Motor timing²

1 - 2.5 second³
 2 - 7 second
 3 - 12 second
 * - N/A with manual valves

Switch options

Automatic valves

0 - VOS1/none
 1 - VOS1/VCS1
 2 - VOS2/VCS2
 3 - VOS2/VCS1
 4 - VOS1HC/VCS1HC

Manual valves

0 - None
 1 - VOS1/VCS1
 2 - VOS2/VCS2
 3 - VOS2/VCS1

Enclosure rating

A - NEMA 4
 B - NEMA 4X

Instruction language

0 - English

¹ 0°F (-18°C) minimum ambient temperature limit

² Motor timing not available on manual valves

³ 2.5 second Motor timing only available on "S" Valves

ACTUATOR ASSEMBLY ROTATION

WARNING

MAXON electro-mechanical valves should be ordered in a configuration compatible with planned piping. If valve orientation is not correct, the actuator assembly can be rotated in 90° increments around the valve body centerline axis using the procedure below.

1. Shut off all electrical power and close off upstream manual cock.
2. Remove terminal block cover plate and disconnect power lead wires. (Tag carefully for later re-assembly.)
3. Remove conduit and electrical leads.
4. Note physical position of any signal switch actuator wands on auxiliary signal switches.
5. Unscrew the two actuator bolts screwed up from the bottom to 1/4 inch. DO NOT completely remove. These bolts secure the valve body to the valve's top assembly housing.
6. Gently lift the top assembly (not more than 1/4" in height); just enough to break the seal between the valve body assembly and the rubber gasket adhering to the bottom of the top housing.

WARNING

Lifting too far may dislodge some small parts inside the top housing, requiring complex re-assembly and retesting by trained factory personnel.

7. Remove the two actuator bolts screwed up from the bottom (were partially unscrewed in step 5).
8. Carefully rotate top assembly to the desired position in a plane parallel to the top of the valve body casting. Rotate the top housing about 30° beyond this position, and then rotate it back. Reposition the top housing back down onto the valve body casting. This should align the open/shut indicator with its window and provide proper alignment of the internal mechanism.
9. Realign holes in valve body casting with the corresponding tapped holes in the bottom of the top assembly housing. Be sure the gasket is still in place between the body and top housing.
10. Reinsert the actuator bolts up from the bottom through the body and carefully engage threads of the top assembly. Tighten securely.
11. Reconnect conduit and electrical leads, then check that signal switch wands are properly positioned and that the open/shut indicator moves freely. Failure to correct any such misalignment can result in extensive damage to the internal mechanism of your valve.
12. Energize valve and cycle several times from closed to full open position. Also electrically trip the valve in a partially opened position to prove valve operates properly.

13. Replace and secure terminal block cover plate and place valve in service.

FIELD INSTALLATION OF VALVE POSITION SWITCH

General

- Shut off fuel supply upstream of valve, then de-energize valve electrically.
- Remove terminal block and access cover to provide access, being careful not to damage gaskets.
- Compare with illustrations below to identify your valve type.

Replacement switches

- Note wand position and mounting hole location carefully, then remove 2 screws and lift existing switch.
- Install replacement switch in same mounting holes on bracket and verify correct wand position.
- Replace existing wiring one connection at a time, following original route and placement.

Add switches

NOTE: Instructions below are written for normally-closed valves. For normally-open valves, reverse switch nomenclature (VOS becomes VCS and vice versa).

- Check illustrations below. If your valve uses a switch mounting bracket as in Fig. 1 & 2, mount switches to bracket using the mounting holes appropriate for valve type and size. For high capacity valves, mount switches on the support stand.
- Position bracket so VCS wand just touches top of actuator, then move downward slightly, depressing wand until switch clicks, then tighten mounting screws to hold this position.
- Pin bracket by drilling 1/8" diameter holes 1/4" deep into bracket mounting pad through drive pin holes, then tap drive pin in until flush (not required for high capacity valves).
- Route wires to wiring compartment as shown, then complete wiring connections and clean out metal drilling chips from previous procedure.
- Cycle valve, checking switch actuation points carefully. (VCS actuates at top of stem stroke, VOS at bottom.) Simultaneously the valve body must be tested for switch continuity and seat leakage. Bend VOS switch wands slightly if necessary to insure valve is opening fully.
- Replace covers, then return valve to service.

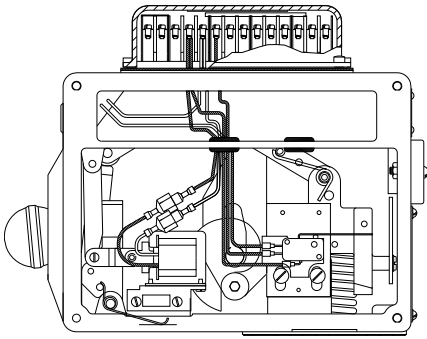

Reference mounting bracket A

Fig. 1

Manual reset actuator
3/4" - 3" S Models

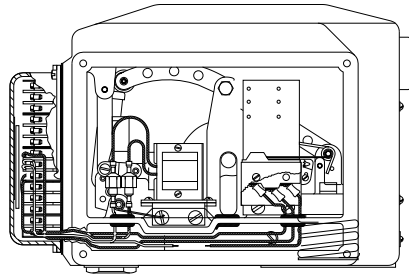

Reference mounting bracket B

Fig. 2

Automatic reset actuator
2-1/2" C - 4" C Models and 6" S Model

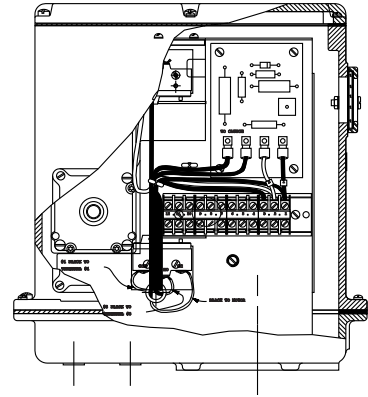

Switches mount on support stand

Fig. 3

Automatic reset actuator
4" & 6" H Models

Wand position (for normally-closed valves)

VOS switch wand should be actuated from above



VCS switch wand should be actuated from below



Mounting brackets

Mounting bracket A

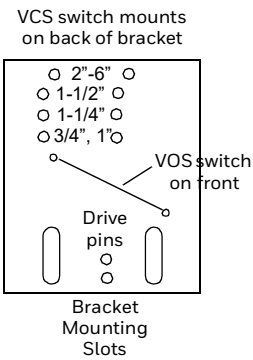

Mounting bracket B

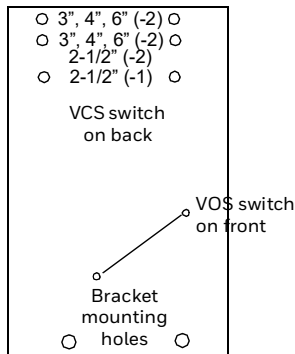

MAINTENANCE INSTRUCTIONS

MAXON electro-mechanical valves are endurance tested far in excess of the most stringent requirements of the various approval agencies. They are designed for long life even if frequently cycled, and to be as maintenance-free and trouble-free as possible. A valve operational test should be performed on an annual basis. If abnormal opening or closing is observed, the valve should be removed from service and your MAXON representative should be contacted. (See MAXON Technical Document 10-35.1.)

Valve leak test should be performed on an annual basis to assure continued safe and reliable operation. Every MAXON valve is operationally tested and meets the requirements of FCI 70-2 Class VI Seat Leakage when in good operable condition. Zero leakage may not be obtained in the field after it has been in service. For specific recommendations on leak test procedures, see MAXON Technical Document 10-35.2. Any valve that exceeds the allowable leakage, as set forth by your local codes or insurance requirements should be removed from service and your MAXON representative should be contacted.

Actuator assembly components require no field lubrication and should never be oiled.

Auxiliary switches, solenoids, motors, clutches or circuit boards may be replaced in the field.



WARNING

Do not attempt field repair of valve body or actuator. Any alterations void all warranties and can create potentially hazardous situations.

If foreign material or corrosive substances are present in the fuel line, it will be necessary to inspect the valve to make certain it is operating properly. If abnormal opening or closing is observed, the valve should be removed from service. Contact your MAXON representative for instructions.

Operator should be aware of and observe characteristic opening/closing action of the valve. Should operation ever become sluggish, remove valve from service and contact MAXON for recommendations.

Address inquiries to MAXON. Local worldwide offices may be located at www.maxoncorp.com. Include valve serial number and nameplate information.

Special Conditions of Safe Use:

Product contains greater than 10% Aluminum.

MA Valves

IEC 61508 Failure Rates in FIT*

Failure Category	λ_{sd}	λ_{su}	λ_{dd}	λ_{du}
FC-D/SR	0 Fit	797 FIT	0 FIT	1170 FIT
FC-F/SR	0 FIT	1342 FIT	0 FIT	625 FIT
FO-F/SR	0 FIT	1410 FIT	0 FIT	557 FIT

FC-D/SR	Normally-Close Shut-Off Series MA11, MA12, MA21, and MA22 Electric Actuated Valves, spring-return – Design Sealing performance
FC-F/SR	Normally-Close Shut-Off Series MA11, MA12, MA21, and MA22 Electric Actuated Valves, spring-return – Full stroke performance
FO-F/SR	Normally-Open Vent Series MA11, MA12, MA21, and MA22 Electric Actuated Valves, spring-return

MM Valves

IEC 61508 Failure Rates in FIT*

Failure Category	λ_{sd}	λ_{su}	λ_{dd}	λ_{du}
FC-D/SR	0 Fit	699 FIT	0 FIT	1137 FIT
FC-F/SR	0 FIT	1244 FIT	0 FIT	592 FIT
FO-F/SR	0 FIT	1312 FIT	0 FIT	524 FIT

FC-D/SR	Normally-Close Shut-Off Series MM11, MM12, MM21, and MM22 Electric Actuated Valves, spring-return – Design Sealing performance
FC-F/SR	Normally-Close Shut-Off Series MM11, MM12, MM21, and MM22 Electric Actuated Valves, spring-return – Full stroke performance
FO-F/SR	Normally-Open Vent Series MM11, MM12, MM21, and MM22 Electric Actuated Valves, spring-return

For More Information

The Honeywell Thermal Solutions family of products includes Honeywell Combustion Safety, Eclipse, Exothermics, Hauck, Kromschröder and Maxon. To learn more about our products, visit ThermalSolutions.honeywell.com or contact your Honeywell Sales Engineer.

Honeywell MAXON branded products

201 E 18th Street
Muncie, IN 47302
USA

www.maxoncorp.com

Honeywell Process Solutions

Honeywell Thermal Solutions (HTS)
1250 West Sam Houston Parkway
South Houston, TX 77042
ThermalSolutions.honeywell

® U.S. Registered Trademark
© 2020 Honeywell International Inc.
32M-95001-03 M.S. 10-20
50116776-001
Printed in United States

